

# CP225

## SMARTBUSINESS WALKIE TALKIE

USER MANUAL



## 1. GENERAL INFORMATION

### 1.1 【Introduction】

The CP225 ARC Ultra mini Business Walkie Talkie combines quality and versatility with an elegant design that ensures effective communications right at your fingertips.

### 1.2 【Key Features】

- ✧ 53CTCSS and 104 DCS
- ✧ Volume setting (1–16)
- ✧ Key Lock
- ✧ Battery Saving
- ✧ 0.5Watt High Power Speaker Output
- ✧ 3.7V 1100mAh Li-Polymer Battery pack
- ✧ Channel Scan—Scans for activity across different communications channels
- ✧ RSSI—Receiving signal strength indication
- ✧ Battery Level Indicator
- ✧ Power Output setting H:L
- ✧ Standby indicator
- ✧ Intelligent ear-microphone adjustment

### 1.3 【Accessories】

- ✧ CB28 Li-Polymer Battery pack
- ✧ CWC18 (S) Charging adapter including Micro-USB cable
- ✧ Owner's manual

### 1.4 【Optional Accessories】

- ◆ EM28 Earbud microphone
- ◆ EM25 Ear-hook microphone
- ◆ EM22 Ear-tube microphone
- ◆ EM38 Earbud microphone
- ◆ EM39 Earbud microphone
- ◆ CS20-25 Charging Stand with CWC20 Adaptor
- ◆ CS28-25 Rapid Charger (4 Slots)

## 2. CONTROLS AND INDICATORS

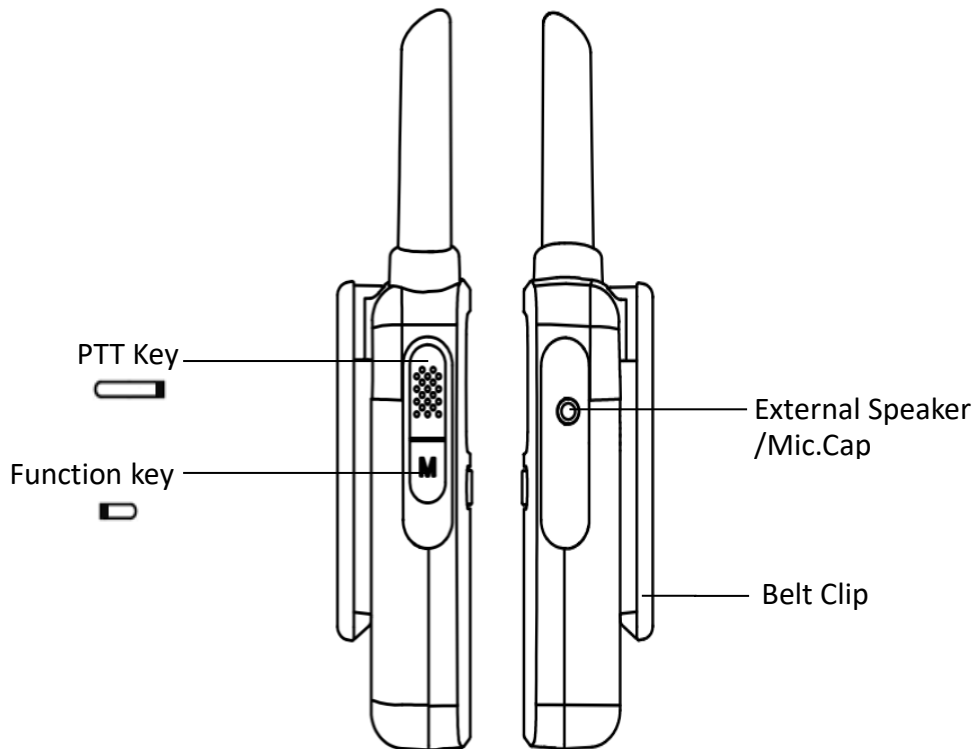
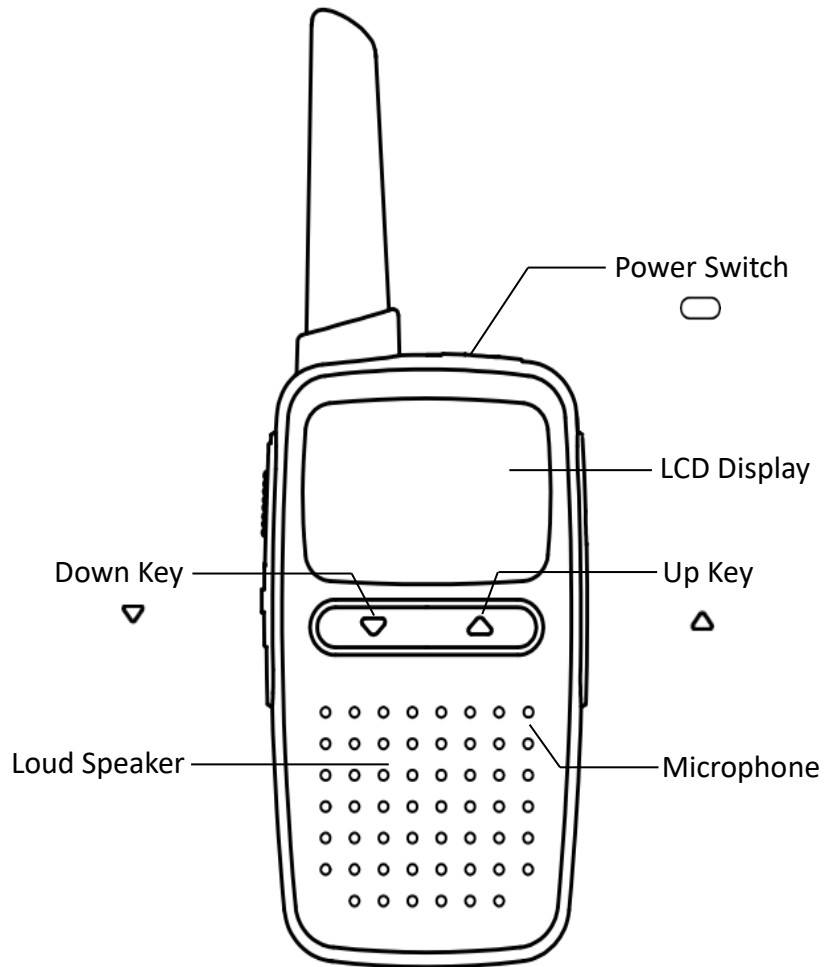

## 2. CONTROLS AND INDICATORS

ENGLISH

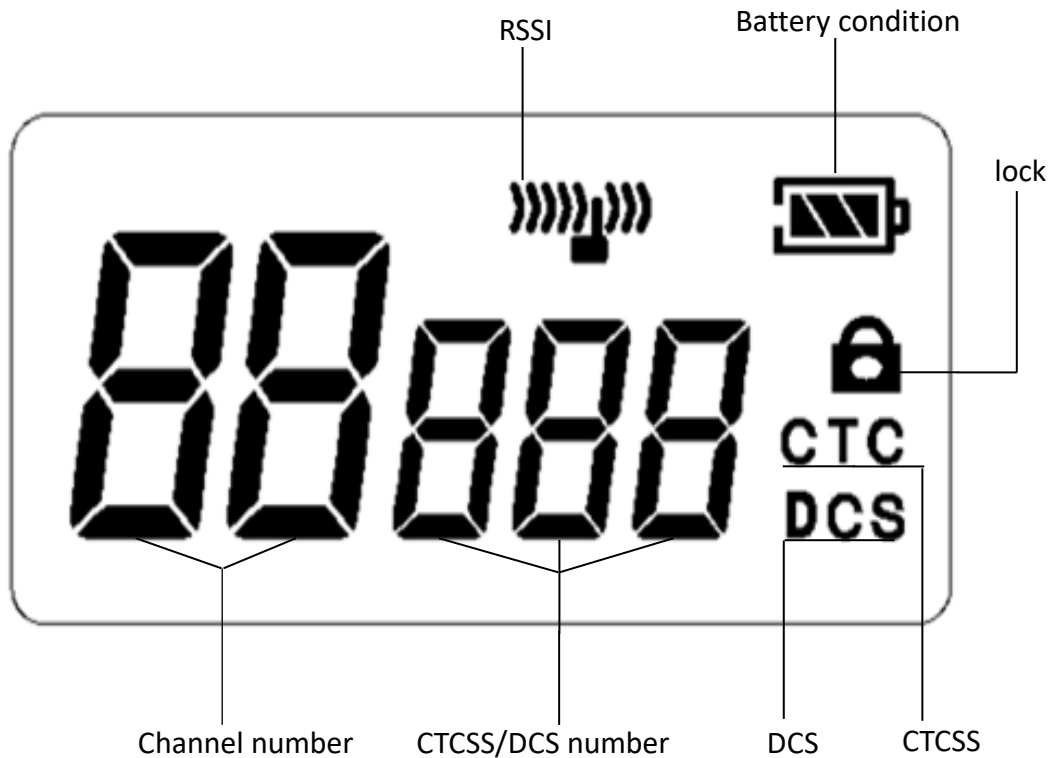

## 3. CHARGING THE BATTERY

### 3.1 【Charging】

- 1) Connect the USB cable to the USB jack of the unit and the other end of the USB cable to the AC adaptor.
  - 2) It will take 3 - 4 hours for full charging.
- Or
- 1) Plug the AC adaptor into a standard electrical outlet
  - 2) Insert the Walkie Talkie into the charging tray for charging.
- It will take 3 – 4 hours for full charging

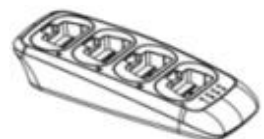
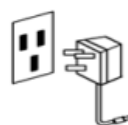
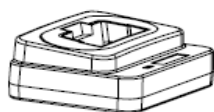

## 4. MENU SETTING

### 4.1 【Menu Setting】

Press [ ] key and [ ] key simultaneously to enter Menu mode, press [ ] key to choose desired menu and press [ ] key to select the function then press [ ] key to save it. If no operation, 10 seconds will automatically exit the menu setting.

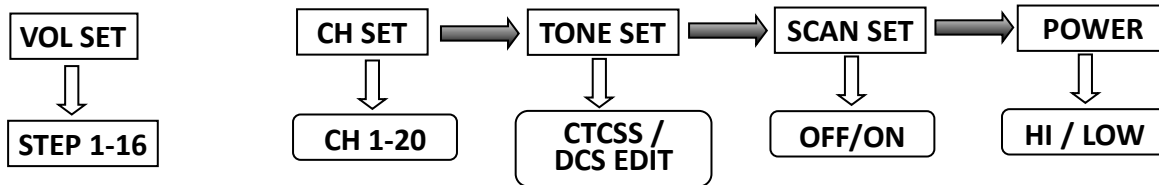

## 5. CHANNEL SETTING BRIEF NOTE

- Press and hold the [ ] key on the top of the unit.
- Press [ ] key and [ ] key simultaneously until the letter CH is blinking, press [ ] key to select the number of Channel.
- Press [ ] key and the screen will display CTC off , press [ ] key to select your desired CTCSS/DCS ( CTCSS 1 – 53, DCS 1 – 104 )
- Press [ ] key until “SC\*\*\*” is blinking, to select the scanning ON/OFF by pressing [ ] key and confirm it by pressing [ ] key. to cancel the scanning by pressing [ ] key.
- Press [ ] key until “Po\*\*\*” is blinking, to select Power HI/Lo by pressing [ ] key and confirm it by pressing [ ] Key.
- Press [ ] key to complete this setting or to press [ ] key again to have the other functions , press [ ] key to select number, you may press [ ] key at any time to complete this setting.
- Press [ ] key at the side and [ ] key simultaneously to LOCK /UNLOCK the unit, after Lock, the unit can only be allowed to adjust volume or transmit and receive.

## 6. OPERATION



### 6.1 【Power On / Off】

To turn the radio on or off, press and hold the power on (  ) key .

### 6.2 【Volume】

Adjust the volume level by using (  ) key (16 steps, default 8)



### 6.3 【Transmission】

Press and hold the (  ) key while speaking at about 5cm from the microphone for transmission. Release the (  ) key to return to standby mode.





### 6.4 【Reception】

Listen for activity on the selected channel.



### 6.5 【Key Lock】

Press (  ) key and (  ) key simultaneously to select Key Lock ON / OFF





### 6.6 【Channel Selection】

Press (  ) key and (  ) until “\*\* CH” is blinking, to select the channel number by pressing (  ) key and confirm it by pressing (  ) key . To select channel quickly, press and hold the (  ) key.



### 6.7 【CTCSS / DCS】

During setting, to press the (  ) key until “CTCSS / DCS\*\*\*” is blinking, to select the CTCSS /DCS number by pressing (  ) key and confirm it by pressing (  ) key.

### 6.8 【Scan】

During setting, to press the (  ) key until “SC\*\*\*” is blinking, to select the scanning ON/OFF by pressing (  ) key and confirm it by pressing (  ) key. to cancel the scanning by pressing (  ) key.

### 6.9 【Power Selection】

During setting, to press the (  ) key until “Po\*\*\*” is blinking, to select power HI/Lo by pressing (  ) key and confirm it by pressing (  ) Key.

### 6.10 【Intelligent ear-mic adjustment】

When plug in ear microphone, the device will automatically reset the volume to comfort level ( originally set by factory or by user whichever the lower )

## 1. 概述

### 1.1 【概述】

CP225 ARC Ultra mini 商用對講機結合了高品質和多功能性以及優美輕巧的設計，確保有效的通信

令您得心應手。

### 1.2 【功能描述】

- ✧ 內置 53 個單音 CTCSS 及 104 個 DCS 數字私線組合 DCS(CTCSS 及 DCS)
- ✧ 音量調較(16 級)
- ✧ 鍵盤鎖功能
- ✧ 省電功能
- ✧ 0.5W 音頻功率輸出
- ✧ 3.7V 1100mAh 鋰高分子電池
- ✧ 頻道掃描
- ✧ 接收訊號強弱顯示(RSSI)
- ✧ 電量狀態顯示
- ✧ 兩檔發射功率可選,高/低
- ✧ 待機提示
- ✧ 智能耳機調較

### 1.3 【配件】

- ✧ CB28 鋰高分子電池
- ✧ USB 充電線及 CWC18 (S)電源適配器
- ✧ 說明書

### 1.4 【另購配件】

- ◆ EM28 耳塞麥克風
- ◆ EM25 耳掛式麥克風
- ◆ EM22 耳管式麥克風
- ◆ EM38 耳塞麥克風
- ◆ EM39 耳塞麥克風
- ◆ CS20-25 充電座連 CWC20 火牛
- ◆ CS28-25 四位快速充電座

## 2. 控制鍵及顯示說明

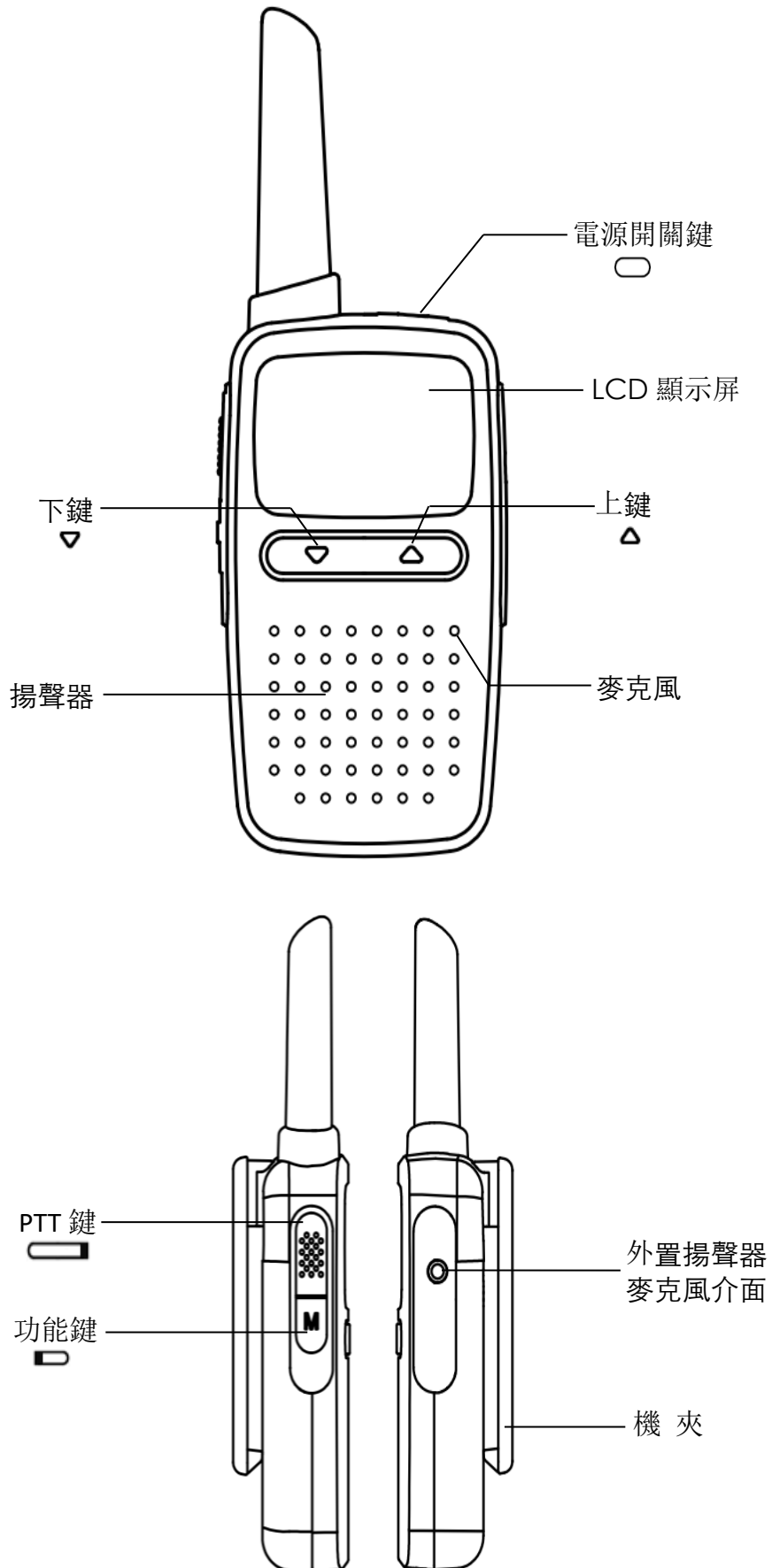



## 2. 控制鍵及顯示說明



## 3. 充電



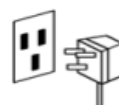
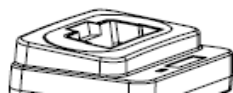
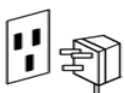

### 3.1 【充電】

- 1) 將 USB 線連接對講機及充電器
- 2) 把 AC 插頭接上 AC 電源
- 3) 充電時間: 3-4 小時  
或
- 1) 將 DC 插頭插入充電座並將電源適配器接入 AC 電源
- 2) 對講機放入充電座進行充電, 充電時間: 3-4 小時









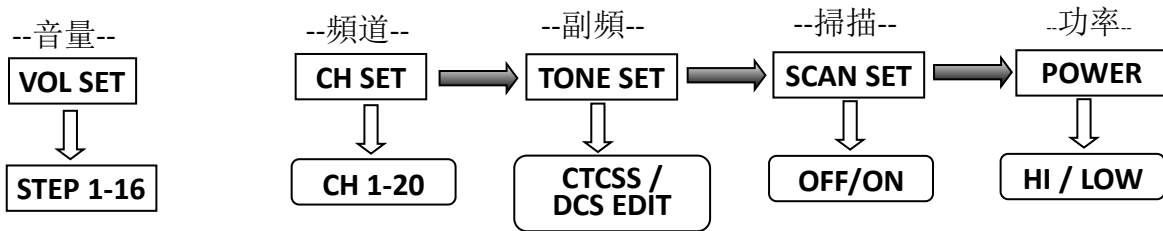

## 4. 功能選擇

### 4.1 【功能選擇】

同時按下 (  ) 鍵及 (  ) 鍵可進入功能選擇，繼續按下 (  ) 鍵可進入所需功能選擇，然後按 (  ) 鍵選擇所需功能，按下機側 (  ) 鍵確認。若無按鍵操作，10 秒後將自動退出選單畫面。



## 5. 簡易調頻方法



- 先在機頂長按 (  ) 鍵開機。
- 同時按下 (  ) 鍵及 (  ) 鍵，直至 LCD 屏幕數字閃動，再按 (  ) 鍵揀選通話頻道。
- 再輕按 (  ) 鍵，LCD 屏幕會出現 CTC OFF，再按 (  ) 鍵揀選副頻道 (CTCSS 1-53,DCS 1-104)。
- 再輕按 (  ) 鍵進入“SC \*\*\*”掃描設置模式，按 (  ) 鍵可選擇開或關，然後按下 (  ) 鍵確認；或按下 (  ) 鍵退出掃描。
- 再輕按 (  ) 鍵進入“Po\*\*\*”可選擇高低發射功率，按 (  ) 鍵選擇高功率 HI/低功率 Lo，按下 (  ) 鍵確認。
- 此時可按下機側 (  ) 鍵完成調頻或可再按 (  ) 鍵跳至以下顯示並以 (  ) 鍵揀選需要的設定，任何時候皆可按下機側 (  ) 鍵完成設定。
- 將機側 (  ) 鍵與 (  ) 鍵同時按下，可以把該機上鎖或開鎖，當上鎖後，此機祇可以調較音量及對講。

## 6. 一般操作



### 6.1 【開機/關機】

持續按下電源 (  ) 鍵開機或關機。

### 6.2 【音量調較】

按 (  |  ) 鍵調較音量(共有 16 級, 出廠預設為 8 級)。

### 6.3 【發射】

持續按下機側 (  ) 鍵對距離麥克風 5cm 講話, 鬆開機側 (  ) 鍵恢復接收狀態。







### 6.4 【接收】

對講機處於待機模式, 以便接收訊號。





### 6.5 【鍵盤鎖】

同時按下 (  ) 鍵及 (  ) 鍵可選擇開或關鍵盤鎖。





### 6.6 【頻道選擇】

同時按下 (  ) 鍵及 (  ) 進入“\*\* CH”頻道選擇模式, 頻道號碼將會閃動, 按 (  |  ) 鍵選擇所需頻道, 再按 (  ) 鍵確認。當持續按 (  |  ) 鍵時, 頻道會不停地調上/調下。





### 6.7 【CTCSS / DCS 模擬亞音頻/數字亞音頻設置】

於調頻時, 按下 (  ) 鍵進入“CTC/DCS\*\*\*”模擬亞音頻/數字亞音頻設置模式, 按 (  |  ) 鍵選擇所需副頻, 然後按下 (  ) 鍵確認 (如開啟此功能, 收發雙方需選用相同的頻道、CTCSS / DCS 代碼才能互相通話)。

### 6.8 【掃描】

於調頻時, 按下 (  ) 鍵進入“SC \*\*\*”掃描設置模式, 按 (  |  ) 鍵可選擇開或關, 然後按下 (  ) 鍵確認; 或按下 (  ) 鍵退出掃描。

### 6.9 【高低功率選擇】

於調頻時, 按下 (  ) 鍵進入“Po\*\*\*”可選擇高低發射功率, 按 (  |  ) 鍵選擇高功率 HI/低功率 Lo, 按下 (  ) 鍵確認。

### 6.10 【智能耳機調較功能】

當插入耳機時, 將自動調較之合適音量 (以出廠值或用戶自選之最低值為標準)

## 1. INFORMATIONS GENERALES

### 1.1 【Introduction】

Le Talkie-Walkie d'affaires CP225 ARC Ultra mini combine qualité et polyvalence avec un design élégant qui assure une communication efficace à portée de main.

### 1.2 【Caractéristiques clés】

- ✧ 53CTCSS et 104 DCS
- ✧ Réglage du volume (1–16)
- ✧ Serrure à clé
- ✧ Économie de batterie
- ✧ Sortie haut-parleur d'une puissance de 0,5 Watt
- ✧ Batterie Li-Polymère de 3,7V 1100mAh
- ✧ Balayage de chaînes—Balayages pour activité à travers différentes chaînes de communication
- ✧ RSSI—Réception de l'indication de force du signal
- ✧ Indicateur du niveau de batterie
- ✧ Réglage de sortie d'alimentation H:L
- ✧ Réglage de l'indicateur
- ✧ Réglage intelligent du micro

### 1.3 【Accessoires】

- ✧ Pack de batterie Li-polymère CB28
- ✧ Adaptateur de charge CWC18 (S) incluant le câble micro-USB
- ✧ Manuel du propriétaire

### 1.4 【Accessoires en option】

- ◆ EM28 Microphone intra-auriculaire
- ◆ EM25 Microphone à crochet d'oreille
- ◆ EM22 Microphone à tube d'oreille
- ◆ EM38 Microphone intra-auriculaire
- ◆ EM39 Microphone intra-auriculaire
- ◆ CS20-25 Support de charge avec adaptateur CWC20
- ◆ CS28-25 Chargeur rapide (4 emplacements)

## 2. CONTRÔLES ET INDICATEURS

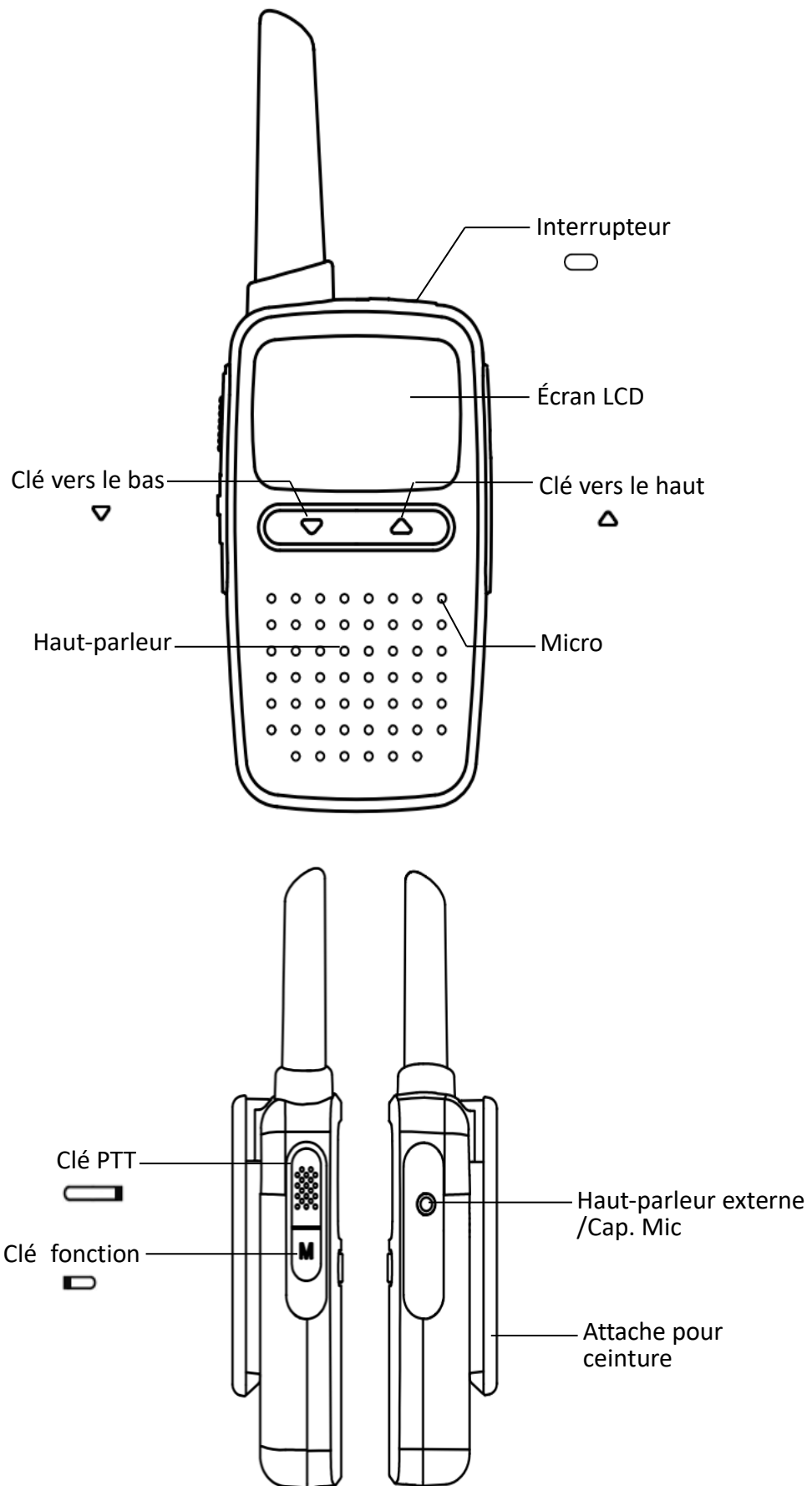

## 2. CONTRÔLES ET INDICATEURS

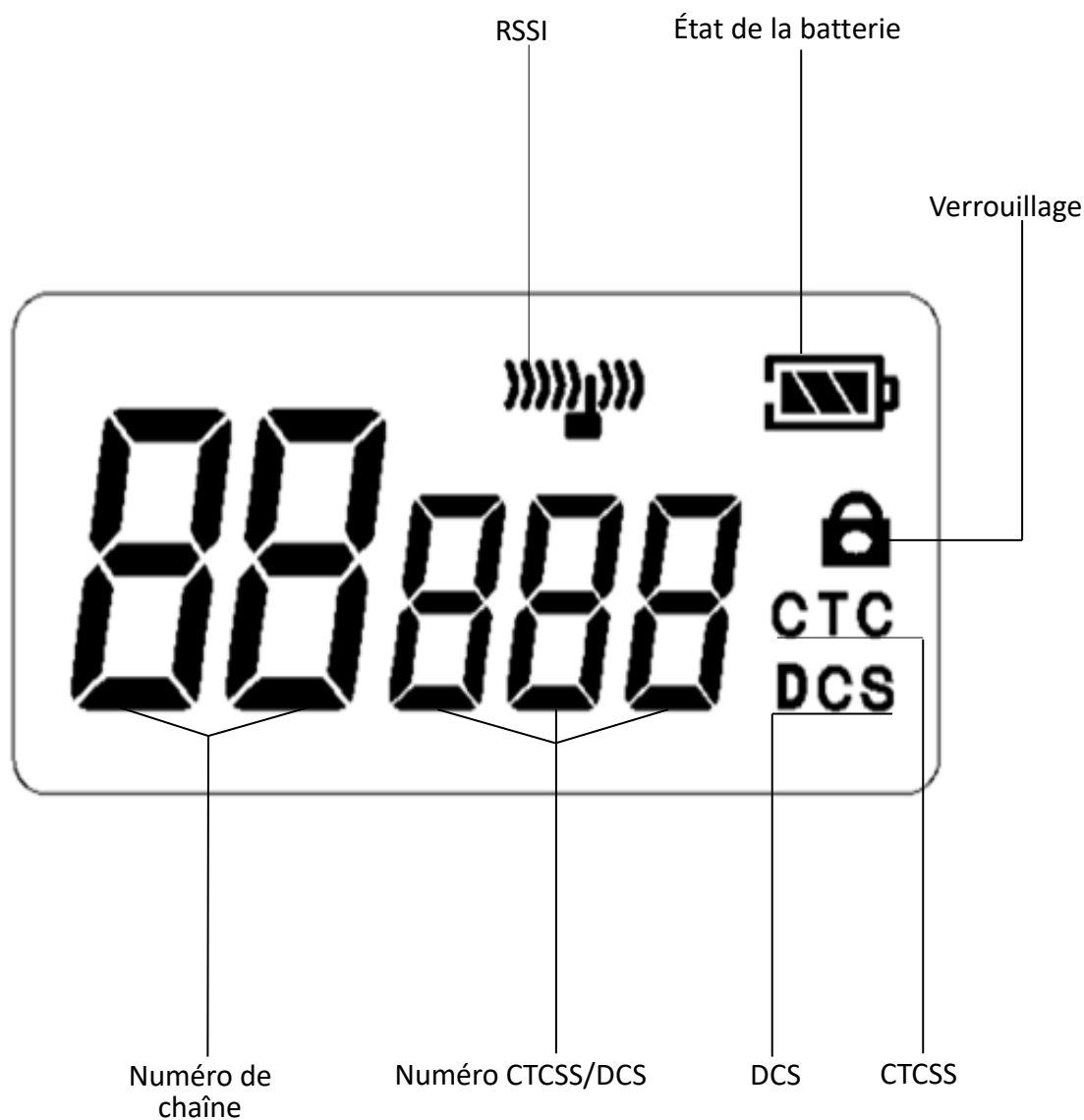

FRENCH

## 3. CHARGER LA BATTERIE

### 3.1 【Charge】

- 1) Brancher le câble USB à la prise USB de l'unité et l'autre extrémité du câble USB à l'adaptateur AC.
- 2) Brancher l'adaptateur AC dans la prise électrique standard.
- 3) être chargé. La charge complète prendra de 3 à 4 heures.



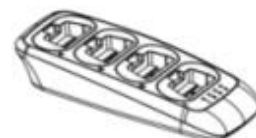
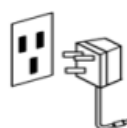
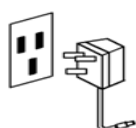

Ou

- 1) Brancher l'adaptateur AC dans la prise électrique standard
- 2) Insérer le Talkie-Walkie dans le bac de chargement pour être chargé. La charge complète prendra de 3 à 4 heures.









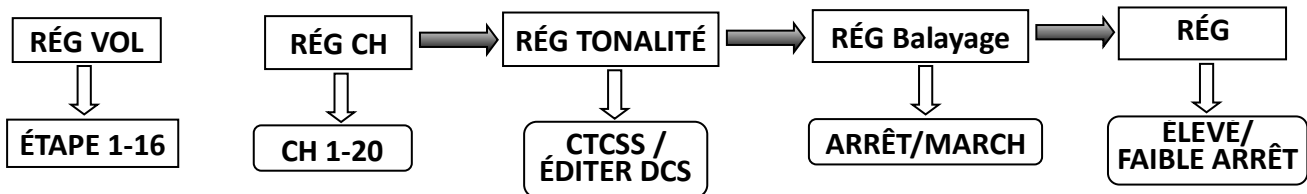











## 4. RÉGLAGE DU MENU

### 4.1 【Réglage du menu】

Appuyer en même temps sur la touche (  ) et la touche (  ) pour entrer en mode Menu, appuyer sur la touche (  ) pour choisir le menu désiré et appuyer sur la touche (  ) pour sélectionner la fonction, puis appuyer sur la touche (  ) pour la sauvegarder. Si aucune opération n'est effectuée après 10 secondes, cela quittera automatiquement le réglage du menu.



## 5. BRÈVE NOTE DE RÉGLAGE DE CHAÎNE

- Appuyer et maintenir la touche (  ) sur le haut de l'unité.
- Appuyer en même temps sur la touche (  ) et la touche (  ) pour jusqu'à ce que la lettre CH clignote, appuyer sur la touche (  ) pour sélectionner le numéro de chaîne.
- Appuyer sur la touche (  ) et l'écran affichera arrêt CTC, appuyer sur la touche (  ) pour sélectionner votre CTCSS/DCS ( CTCSS 1 – 53, DCS 1 – 104 ) souhaité
- Appuyer sur la touche (  ) jusqu'à ce que «SC\*\*\* » clignote, pour sélectionner BALAYAGE MARCHÉ /ARRÊT en appuyant sur la touche (  ) et confirmer en appuyant sur la touche (  )
- Appuyer sur la touche (  ) jusqu'à ce que « Po \*\*\* » clignote, pour sélectionner la puissance élevée/faible en appuyant sur la touche (  ) et confirmer en appuyant sur la touche (  )
- Appuyer sur la touche (  ) pour terminer ce réglage ou appuyer à nouveau sur la touche (  ) pour obtenir les autres fonctions, appuyer sur la touche (  ) pour sélectionner Oui ou Non des fonctions, vous pouvez appuyer sur la touche (  ) à tout moment pour terminer ce réglage.
- Appuyer sur la touche (  ) sur le côté et en même temps sur la touche (  ) pour VERROUILLER/DÉVERROUILLER l'unité, après Verrouillage, l'unité peut uniquement être Autorisée pour régler le volume ou transmettre et recevoir.

## 6. FONCTIONNEMENT



### 6.1 【 Mise sous tension/hors tension 】

Pour allumer la radio ou l'éteindre, appuyer et maintenir la tension sur la touche (  ) .

### 6.2 【 Volume 】

Régler le niveau du volume en utilisant la touche (  ) (16 étapes, défaut 8)



### 6.3 【 Transmission 】

Appuyer et maintenir la touche (  ) tout en parlant à environ 5cm du micro pour la transmission. Relâcher la touche (  ) pour revenir au mode veille.







### 6.4 【 Réception 】

Écouter l'activité sur la chaîne sélectionnée.





### 6.5 【 Serrure à clé 】

Appuyer en même temps sur la touche (  ) et la touche (  ) pour sélectionner Serrure clé MARCHE/ARRÊT





### 6.6 【 Sélection de chaînes 】

Appuyer en même temps sur la touche (  ) et la touche (  ) pour jusqu'à ce que « \*\* CH » clignote, sélectionner le numéro de chaîne en appuyant sur la touche (  |  ) et confirmer en appuyant sur la touche (  ) . Sélectionner rapidement la chaîne, appuyer et maintenir la touche (  |  ) .





### 6.7 【 CTCSS / DCS 】

Pendant le réglage, appuyer sur la touche (  ) jusqu'à ce que « CTCSS / DCS\*\*\* » clignote, sélectionner le numéro CTCSS /DCS en appuyant sur la touche (  |  ) et confirmer en appuyant sur la touche (  ) .

### 6.8 【 Balayage 】

Pendant le réglage, appuyer sur la touche (  ) jusqu'à ce que « SC\*\*\* » clignote, pour sélectionner BALAYAGE MARCHE /ARRÊT en appuyant sur la touche (  |  ) et confirmer en appuyant sur la touche (  )

### 6.9 【 Sélection de la puissance 】

Pendant le réglage, appuyer sur la touche (  ) jusqu'à ce que « Po \*\*\* » clignote, pour sélectionner la puissance élevée/faible en appuyant sur la touche (  |  ) et confirmer en appuyant sur la touche (  ) .

### 6.10 【 Réglage intelligent du micro-casque 】

Lorsque le microphone est branché, l'appareil rétablit automatiquement le volume au niveau confort (réglé à l'origine par l'usine ou par l'utilisateur selon la valeur la plus basse)



# 1. ALLGEMEINE INFORMATION

## 1.1 【Einführung】

Das CP225 ARC Ultra mini Business Walkie Talkie verbindet Qualität und Vielseitigkeit mit einem eleganten design, das eine effektive Kommunikation nur mit Ihren Fingerspitzen sicherstellt.

## 1.2 【Hauptmerkmale】

- ✧ 53CTCSS und 104 DCS
- ✧ Lautstärkeneinstellung (1 – 16)
- ✧ Tastensperre
- ✧ Batterie-Schonung
- ✧ 0,5 Watt Hochleistungs- Lautsprecher-Ausgang
- ✧ 3,7V 1100mAh Li-Polymer-Batterie
- ✧ Channel Scan—Scans für die Aktivität über verschiedene Kommunikationskanäle
- ✧ RSSI—Receiving signal strengte indication (= Anzeige der Signalstärke)
- ✧ Batteriestandsanzeiger
- ✧ Einstellung der Ausgangsleistung H:L
- ✧ Der Standby-Anzeige
- ✧ Intelligente Ohr-Mikrofon-Einstellung

## 1.3 【Zubehör】

- ✧ CB28-Li-Polymer-Batterie
- ✧ CWC18 (S) Auflade-Adapter einschließlich Micro-USB-Kabel
- ✧ Handbuch des Besitzers

## 1.4 【Optionaler Zubehör】

- ◆ EM28 Ohrhörmikrofon
- ◆ EM25 Ohrbügelmikrofon
- ◆ EM22 Ohrschlauchmikrofon
- ◆ EM38 Ohrhörmikrofon
- ◆ EM39 Ohrhörmikrofon
- ◆ CS20-25 Ladestation mit CWC20-Adapter
- ◆ CS28-25 Schnellladegerät (4 Slots)

## 2. STEUERUNGEN UND ANZEIGEN

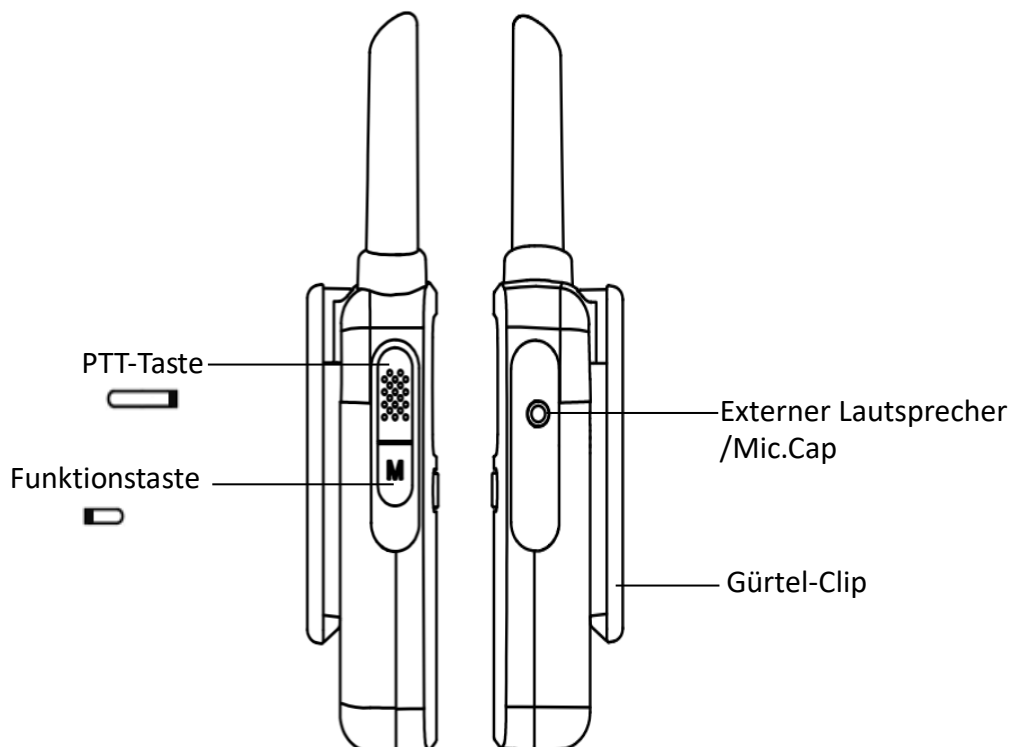
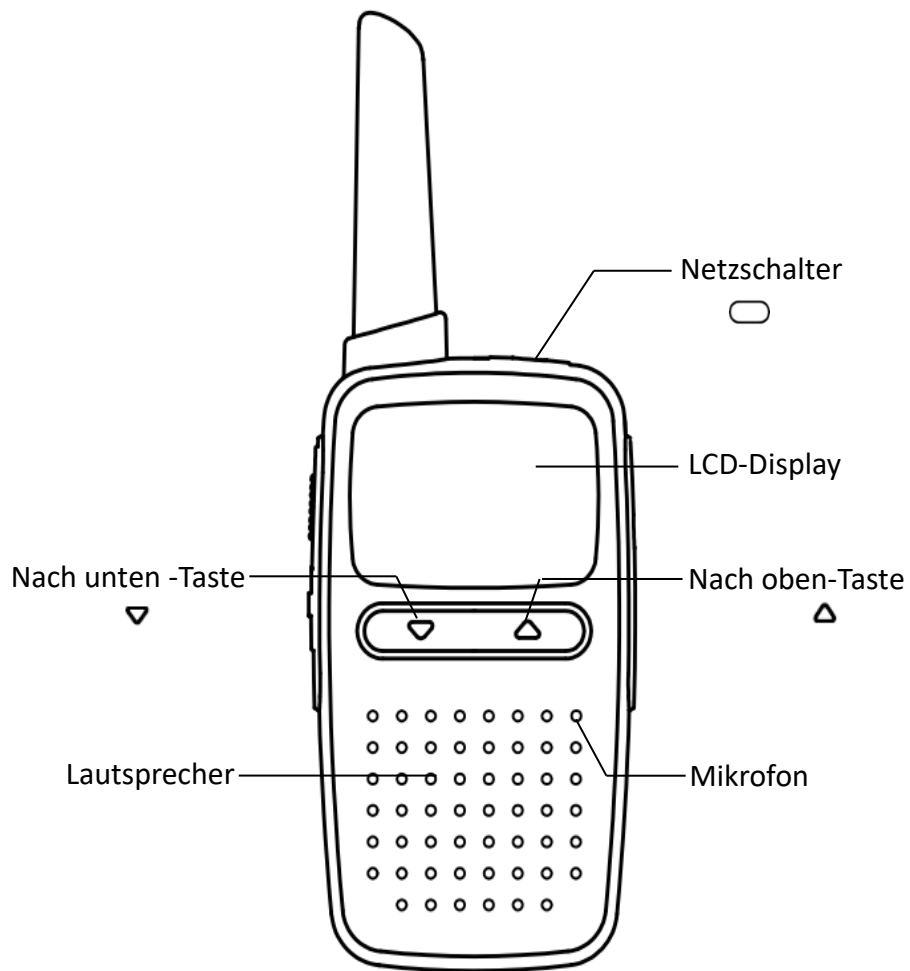

## 2. STEUERUNGEN UND ANZEIGEN

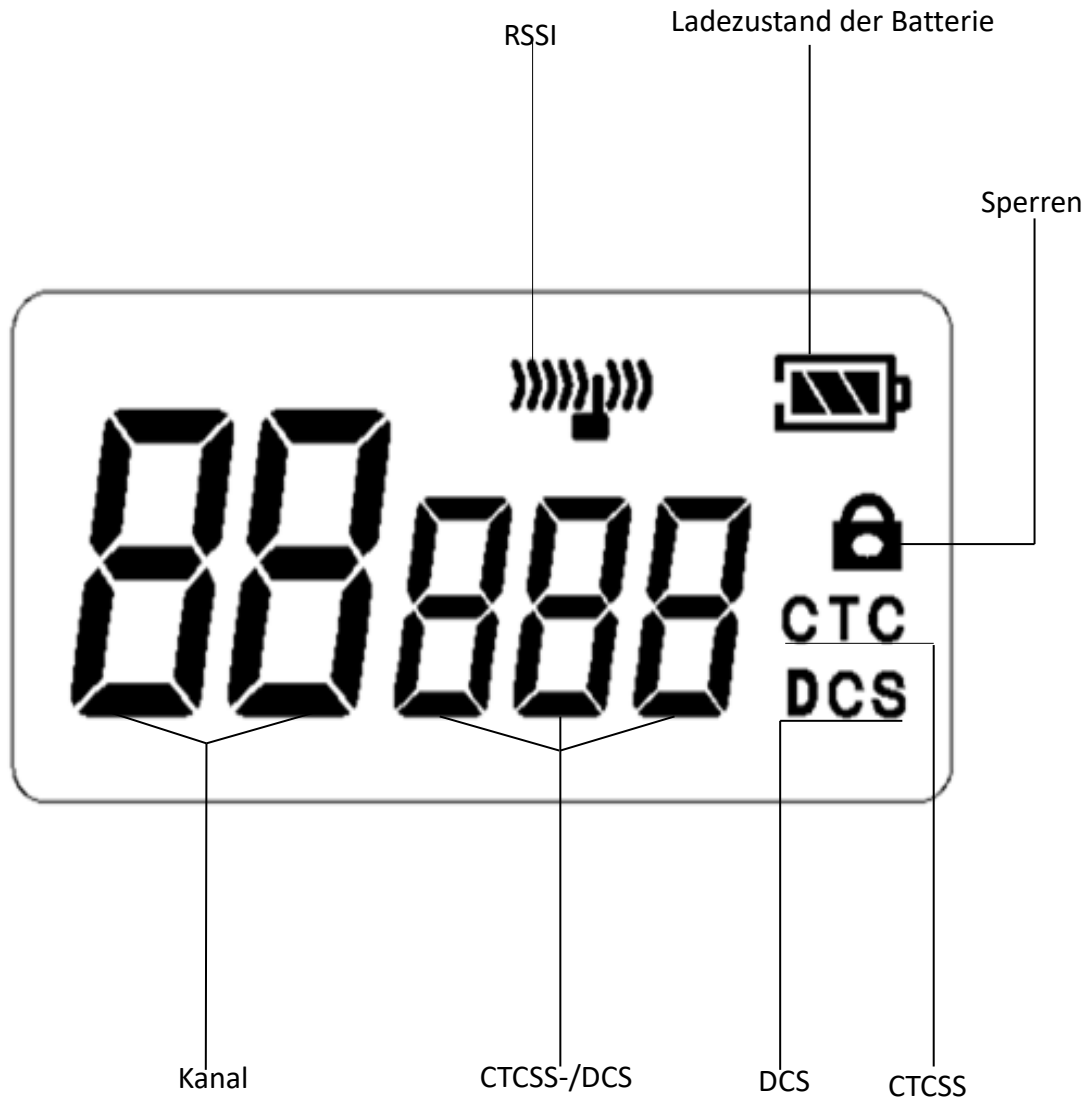

## 3. AUFLADEN DER BATTERIE

### 3.1 【Aufladen】

- 1) Schließen Sie das USB-Kabel an die USB-Buchse und das andere Ende des USB-Kabels an den Wechselstrom-Adapter an.
- 3) Stecken Sie den Wechselstrom-Adapter in eine Standardsteckdose.  
Eine Vollladung dauert 3 bis 4 Stunden



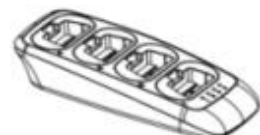
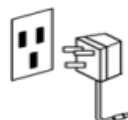
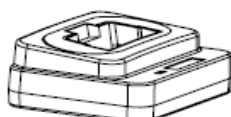
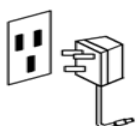

Oder

- 1) Stecken Sie den Wechselstrom-Adapter in eine Standardsteckdose.
- 2) Stellen Sie das Walkie Talkie zum Aufladen auf das Aufladegerät.  
Eine Vollladung dauert 3 bis 4 Stunden









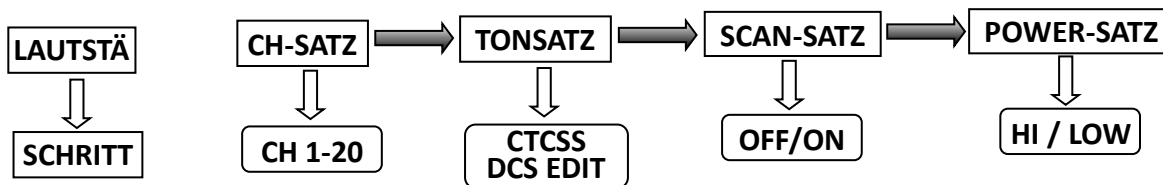











## 4. MENÜEINSTELLUNGEN

### 4.1 【Menüeinstellungen】

Drücken Sie die (  ) Taste und die (  ) Taste gleichzeitig, um in den Menü-Modus zu gelangen, drücken Sie die (  ) Taste, um das gewünschte Menü auszuwählen, und drücken Sie die (  ) Taste, um die Funktion auszuwählen, drücken Sie dann die (  ) Taste, um sie zu speichern. Wenn 10 Sekunden nicht in Betrieb, wird die Menüeinstellung automatisch beendet.



## 5. KANALEINSTELLUNG KURZER HINWEIS

- Drücken Sie die (  ) Taste oben auf dem Gerät und halten Sie sie gedrückt.
- Drücken Sie die (  ) Taste und die (  ) Taste gleichzeitig, bis der Buchstabe CH blinkt, drücken Sie die (  ) Taste, um den Kanal auszuwählen.
- Drücken Sie die (  ) Taste, und auf dem Bildschirm wird CTC angezeigt, drücken Sie die (  ) Taste, um Ihre gewünschte CTCSS / DCS (CTCSS 1-53, DCS 1-104) auszuwählen
- Drücken Sie die (  ) Taste, bis "SC\*\*\*" blinkt, um mit der (  ) Taste SCAN ON/OFF auszuwählen, und bestätigen Sie mit der (  ) Taste.
- Drücken Sie die (  ) Taste, bis "Po\*\*\*" blinkt, um mit der (  ) Taste Power Hi/Low auszuwählen, und bestätigen Sie mit der (  ) Taste.
- Drücken Sie die (  ) Taste, um diese Einstellung abzuschließen, oder drücken Sie die (  ) Taste erneut, um zu anderen Funktionen zu gelangen, drücken Sie die (  ) Taste Ja oder Nein der Funktionen, Sie können jederzeit die (  ) Taste drücken, um diese Einstellung abzuschließen.
- Drücken Sie die (  ) Taste an der Seite und gleichzeitig die (  ) Taste, um das Gerät zu SPERREN/ENTSPERREN, nach dem Sperren können nur noch die Lautstärke des Gerätes oder die Übertragung und der Empfang des Gerätes eingestellt werden.



### 6.1 【Ein- / Ausschalten】

Um das Gerät ein- oder auszuschalten, drücken Sie die (  ) Taste und halten Sie sie gedrückt.

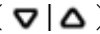
### 6.2 【Lautstärke】

Stellen Sie die Lautstärke mit der (  ) Taste ein (16 Stufen, Standard 8) ein.



### 6.3 【Übertragung】

Drücken Sie die (  ) Taste und halten Sie sie gedrückt, während Sie zur Übertragung mit einem Abstand von 5 cm vom Mikrofon sprechen. Lassen Sie die (  ) Taste los, um in den Standby-Modus zurückzukehren.





### 6.4 【Empfang】

Hören Sie der Aktivität auf dem ausgewählten Kanal zu.

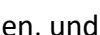

### 6.5 【Tastensperre】

Drücken Sie die (  ) Taste und die (  ) Taste gleichzeitig, um Tastensperre ON / OFF auszuwählen.

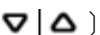

### 6.6 【Kanalauswahl】

Drücken Sie die (  ) Taste und die (  ) Taste gleichzeitig, bis “\*\* CH” blinkt, um den Kanal über die (  ) Taste auszuwählen, und bestätigen Sie mit der (  ) Taste. Um den Kanal schnell auszuwählen, drücken Sie die (  ) Taste und halten Sie sie gedrückt.



### 6.7 【CTCSS / DCS】

Drücken Sie beim Einstellen die (  ) Taste, bis „CTCSS / DCS \*\*\*“ blinkt, um die CTCSS / DCS-Kanal auszuwählen, drücken Sie die (  ) Taste und bestätigen Sie mit der (  ) Taste.

### 6.8 【Scan】

Drücken Sie beim Einstellen die (  ) Taste, bis “SC\*\*\*“ blinkt, um mit der (  ) Taste SCAN ON/OFF auszuwählen, und bestätigen Sie mit der (  ) Taste.

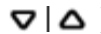
### 6.9 【Power-Auswahl】

Drücken beim Einstellen die (  ) Taste, bis “Po\*\*\*“ blinkt, um mit der (  ) Taste Power Hi/Low auszuwählen, und bestätigen Sie mit der (  ) Taste.

### 6.10 【Intelligente Einstellung des Ohr-Mic】

Wenn Sie das Ohrmikrofon einstecken, setzt das Gerät die Lautstärke automatisch auf die Komfort-Lautstärke zurück (Ursprüngliche Werkseinstellung oder die Benutzereinstellung, welche auch immer niedriger ist)

## 1. INFORMACIÓN GENERAL

### 1.1 【Introducción】

El walkie-talkie de negocio CP225 ARC Ultra mini combina calidad y flexibilidad con un diseño elegante que garantiza comunicaciones eficaces a su alcance.

### 1.2 【Características clave】

- ✧ 53CTCSS y 104 DCS
- ✧ Ajuste de volumen (1–16)
- ✧ Cerradura con llave
- ✧ Ahorro de batería
- ✧ Salida de altavoz de potencia de 0.5Watt
- ✧ Batería de polímero de litio de 3.7V 1100mAh
- ✧ Escaneo de canales —Escaneos de actividad por diferentes canales de comunicación
- ✧ RSSI—Indicador de fuerza de la señal recibida
- ✧ Indicador del nivel de batería
- ✧ Ajuste de salida de potencia H:L
- ✧ Indicador de espera
- ✧ Ajuste inteligente del micrófono

### 1.3 【Accesorios】

- ✧ CB28 Paquete de batería de polímero de litio
- ✧ Adaptador de carga CWC18 (S), incluso cable Micro-USB
- ✧ Manual de propietario

### 1.4 【Accesorios opcionales】

- ◆ EM28 Micrófono Earbud
- ◆ EM25 Micrófono de gancho de oreja
- ◆ EM22 Micrófono de tubo de oído
- ◆ EM38 Micrófono Earbud
- ◆ EM39 Micrófono Earbud
- ◆ CS20-25 Soporte de carga con adaptador CWC20
- ◆ CS28-25 Cargador rápido (4 ranuras)

## 2. MANDOS E INDICADORES

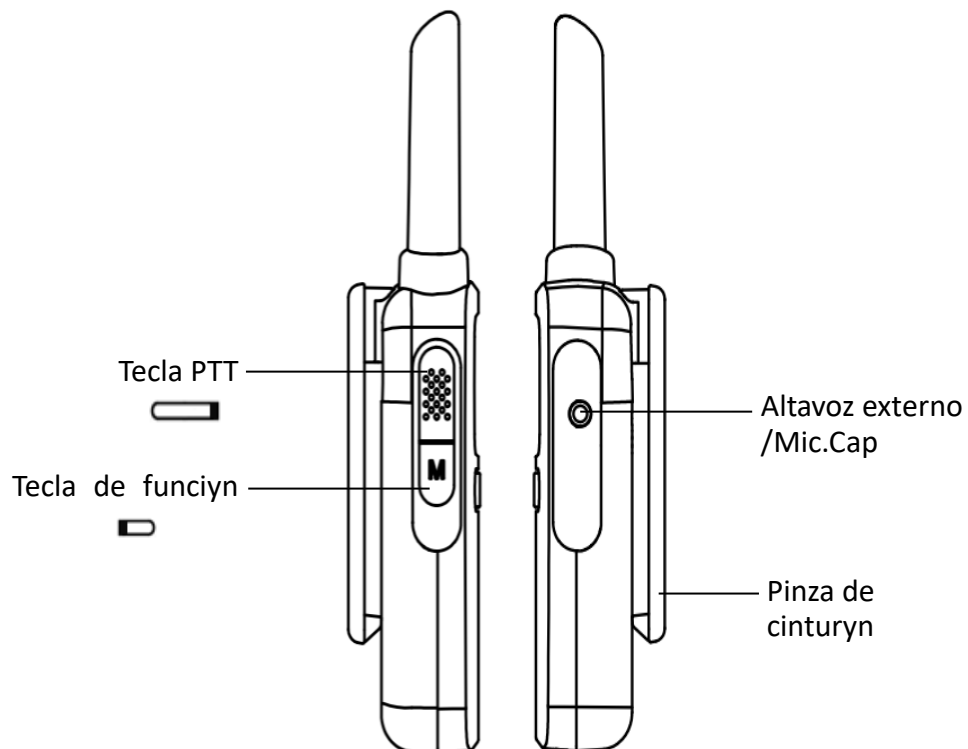
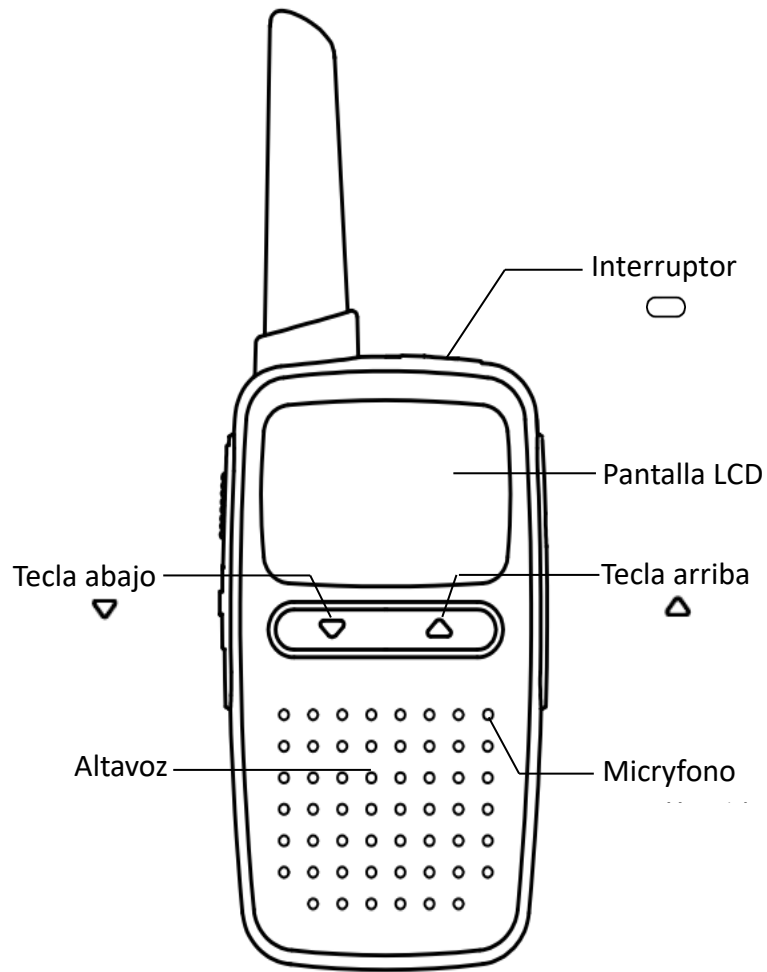

## 2. MANDOS E INDICADORES

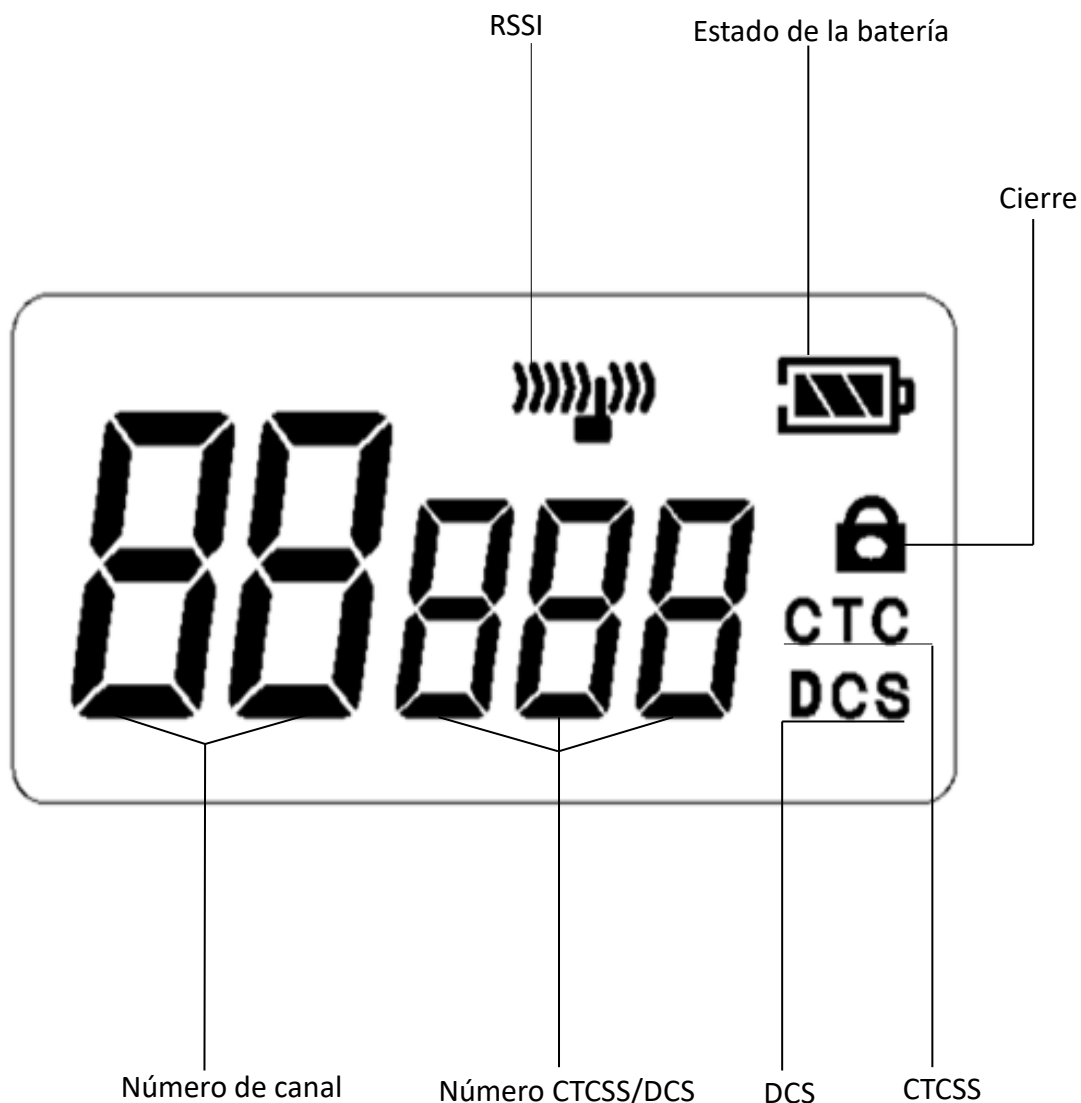

SPANISH

## 3. CARGAR LA BATERÍA

### 3.1 【Carga】



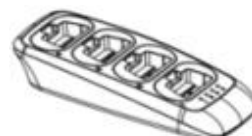
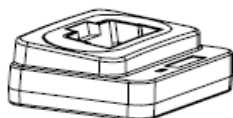
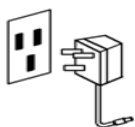

- 1) Conectar el cable USB a la toma USB de la unidad y la otra extremidad del cable USB al adaptador CA.
  - 2) Conectar el adaptador CA a un enchufe eléctrico estándar.
  - 3) La carga completa se efectuará de 3 a 4 horas
- O
- 1) Enchufar el adaptador CA a un enchufe eléctrico estándar
  - 2) Insertar el walkie-talkie en el soporte de carga para cargar. La carga completa se efectuará de 3 a 4 horas











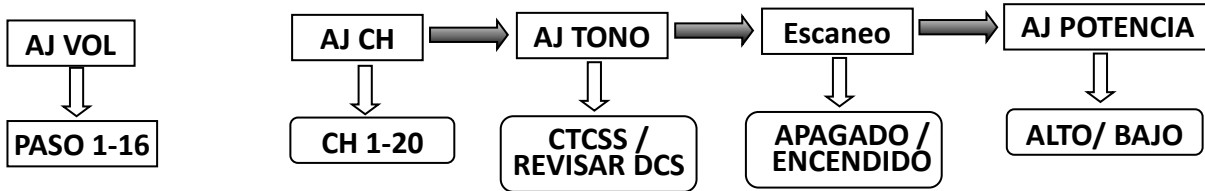











## 4. AJUSTE DEL MENÚ

### 4.1 [Ajuste del menú]

Pulsar simultáneamente la tecla (  ) y la tecla (  ) entrar en el modo Menú, pulsar la tecla (  ) para elegir el menú deseado y pulsar la tecla (  ) para seleccionar la función, luego pulsar la tecla (  ) para guardarla. Si ninguna operación se ha efectuado dentro de 10 segundos, el ajuste del menú se abandonará automáticamente.



## 5. NOTAS BREVES DEL AJUSTE DE CANAL

- Pulsar y mantener pulsada la tecla (  ) en la parte superior de la unidad.
- Pulsar simultáneamente la tecla (  ) y la tecla (  ) hasta que la letra CH empiece a parpadear, pulsar la tecla (  ) para seleccionar el número del canal.
- Pulsar la tecla (  ) y la pantalla visualizará apagado CTC, pulsar la tecla (  ) para seleccionarsu CTCSS/DCS ( CTCSS 1 – 53, DCS 1 – 104 ) deseado.
- pulsar la tecla (  ) hasta que “SC\*\*\*” empiece a parpadear, seleccionar ESCANEAO ENCENDIDO/ APAGADO pulsando la tecla (  ) y confirmar pulsando la tecla (  ) .
- pulsar la tecla (  ) hasta que “Po\*\*\*” empiece a parpadear,seleccionar la potencia alta/ baja pulsandola tecla (  ) y confirmar p ulsando la tecla (  ) .
- Pulsar la tecla (  ) para completar este ajuste o volver a pulsar la tecla (  ) para obtener las otras funciones, pulsar la tecla (  ) para seleccionar Sí o No de las funciones, usted puede pulsar la tecla (  ) en cualquier momento para completar el ajuste.
- Pulsar la tecla (  ) en la parte yNivel de Silenciador tecla (  ) para CERRAR/ ABRIR la unidad, después Cierre, la unidad puede autorizarse solo para ajustar el volumen o transmitir y recibir.

## 6. FUNCIONAMIENTO



### 6.1 【Encender/ Apagar】

Para encender o apagar la radio, pulsar y mantener pulsado la tecla (  ) .

### 6.2 【Volumen】

Ajustar el nivel del volumen usando la tecla (  ) (16 pasos, 8 preestablecidos)



### 6.3 【Transmisión】

Pulsar y mantener pulsada la tecla (  ) hablando a una distancia de 5 cm del micrófono para la transmisión. Liberar la tecla (  ) para volver al modo de espera.





### 6.4 【Recepción】

Escuchar la actividad en el canal seleccionado.



### 6.5 【Cierre con llave】

Pulsar simultáneamente la tecla (  ) y la tecla (  ) para seleccionar CIERRE CON LLAVE ENCENDIDO/ APAGADO



### 6.6 【Selección de canal】

Pulsar simultáneamente la tecla (  ) y la tecla (  ) hasta que “\*\* CH” empiece a parpadear, seleccionar el número de canal pulsando la tecla (  ) y confirmar pulsando la tecla (  ) . Para seleccionar rápidamente el canal, pulsar y mantener pulsada la tecla (  ) .



### 6.7 【CTCSS / DCS】

Durante el ajuste, pulsar la tecla (  ) hasta que “CTCSS / DCS\*\*\*” empiece a parpadear, seleccionar el número CTCSS /DCS pulsando la tecla (  ) y confirmar pulsando la tecla (  ) .

### 6.8 【Escaneo】

Durante el ajuste, pulsar la tecla (  ) hasta que “SC\*\*\*” empiece a parpadear, seleccionar ESCANEADO ENCENDIDO/ APAGADO pulsando la tecla (  ) y confirmar pulsando la tecla (  ) .

### 6.9 【Selección de potencia】

Durante el ajuste, pulsar la tecla (  ) hasta que “Po\*\*\*” empiece a parpadear, seleccionar la potencia alta/ baja pulsando la tecla (  ) y confirmar pulsando la tecla (  ) .

### 6.10 【Ajuste inteligente del auricular con micrófono】

Cuando el micrófono está conectado, el dispositivo restablecerá automáticamente el volumen en el nivel de confort (ajustado originariamente en la fábrica o por el usuario según el valor más bajo).

## 1. 일반 정보

### 1.1 【소개】

CP225 ARC Ultra mini 비즈니스 위키토키는 품격 있는 디자인에 품질과 다기능성을 겸비하여 손가락

하나로 원활한 커뮤니케이션을 도와줍니다.

### 1.2 【주요 특징점】

- ◇ 53CTCSS 및 104 DCS
- ◇ 볼륨 설정 (1 - 16)
- ◇ 키 잠금
- ◇ 배터리 절약
- ◇ 0.5Watt 고출력 스피커 출력
- ◇ 3.7V 1100mAh 리튬 폴리머 배터리 팩
- ◇ 채널 스캔—상이한 통신 채널에 걸친 활동을 스캔한다
- ◇ RSSI—Receiving signal strength indication, 수신신호강도
- ◇ 배터리 레벨 표시등
- ◇ 송신출력설정 H:L
- ◇ 대기 표시등
- ◇ 지능형 이어폰-마이크 조정

### 1.3 【액세서리】

- ◇ CB28 리튬 폴리머 배터리 팩
- ◇ CWC18 (S)충전어댑터, **Micro-USB** 케이블포함
- ◇ 사용 설명서

### 1.4 【운용 액세서리】

- ◆ EM28 이어폰 마이크
- ◆ EM25 이어 후크 마이크
- ◆ EM22 이어폰 마이크
- ◆ EM38 이어폰 마이크
- ◆ EM39 이어폰 마이크
- ◆ CS20-25 충전 스탠드 CW20 어댑터가있는
- ◆ CS28-25 급속 충전기 (4 슬롯)

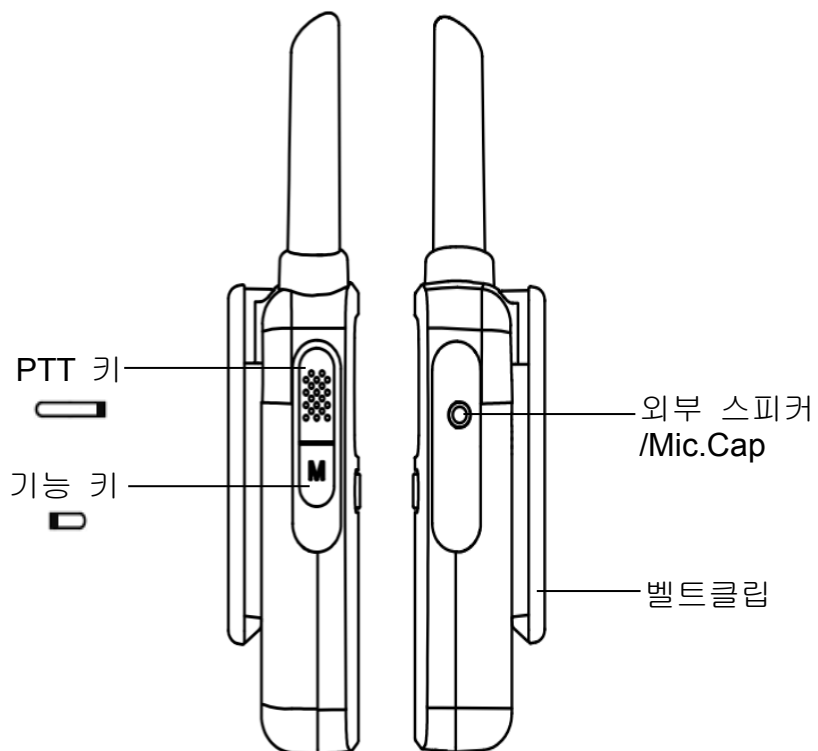
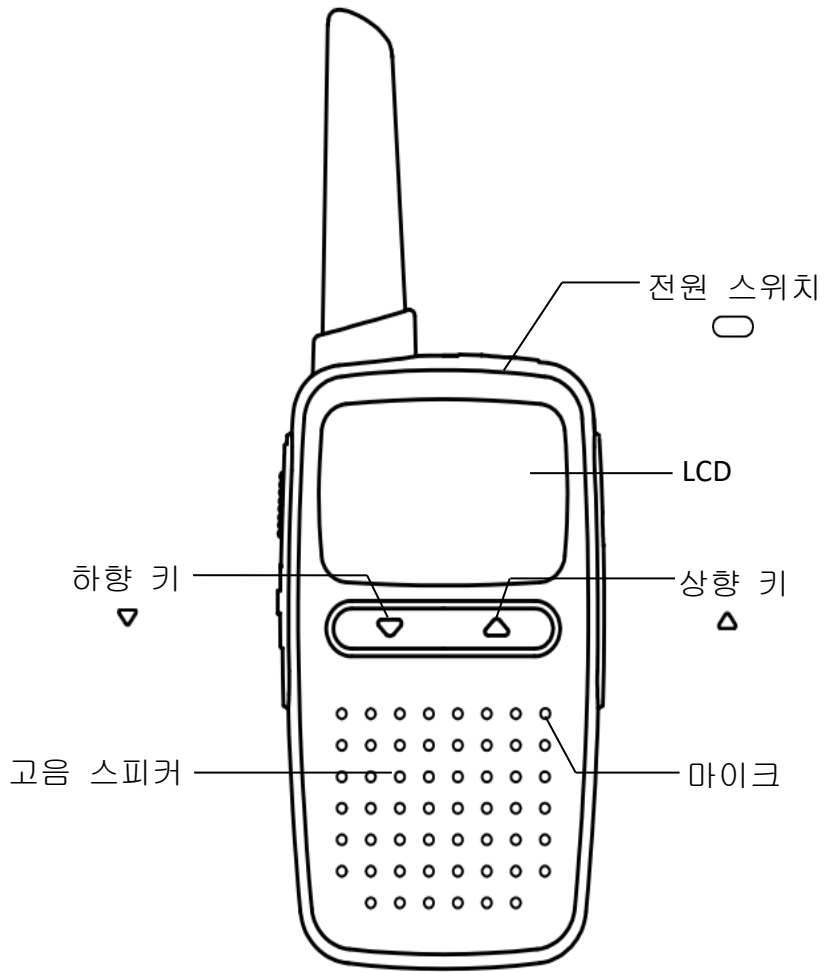

## 2. 제어 및 표시등

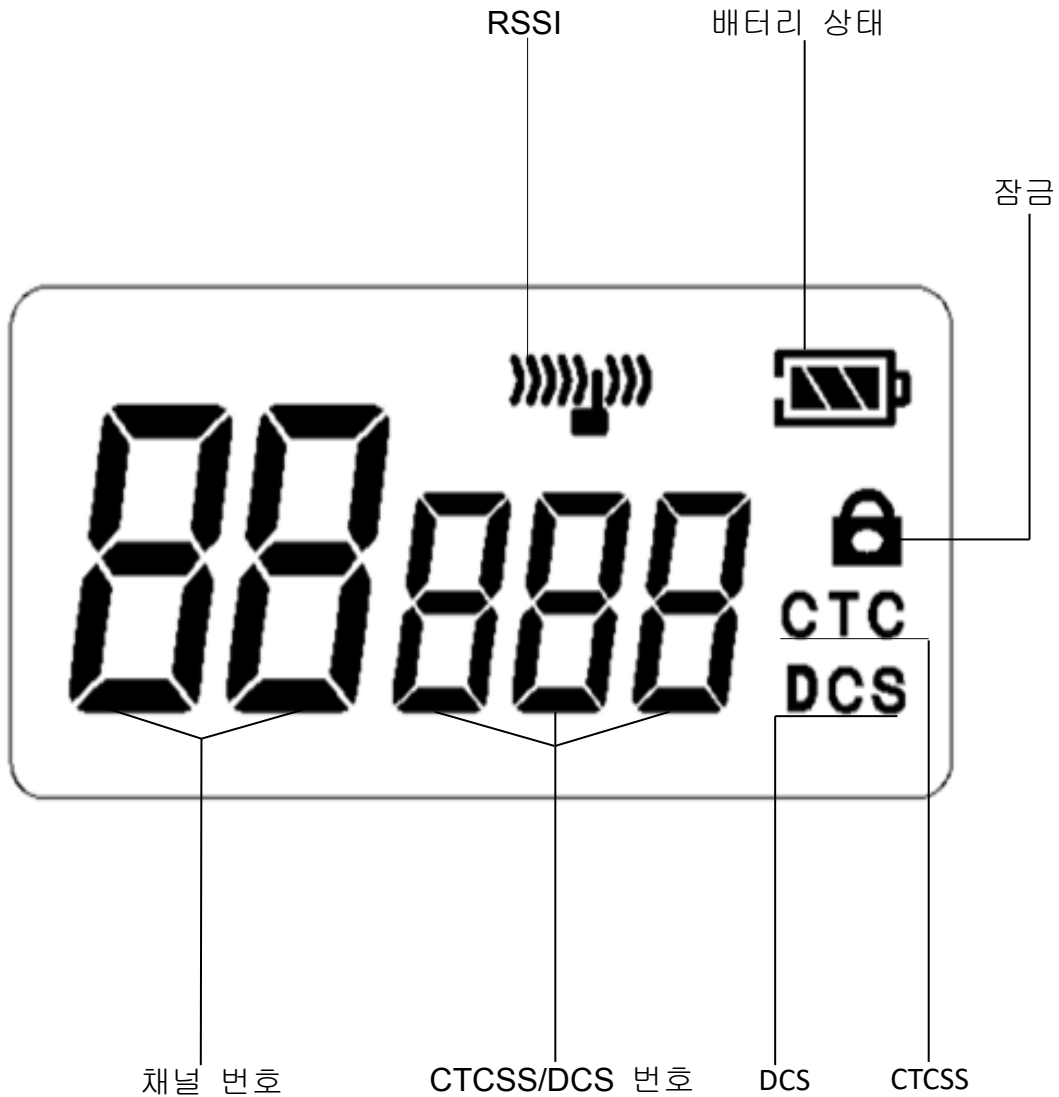

## 3. 배터리 충전

### 3.1 【충전】

- 1) USB 케이블을 장치의 USB 잭에 연결하고 USB 케이블의 다른 끝을 AC 어댑터에 연결합니다.
- 2) AC 어댑터를 표준 전기 인출구에 꽂습니다.
- 3) 만충전에는 3 - 4 시간이 소요됩니다.



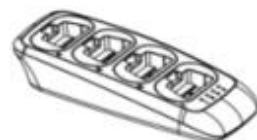
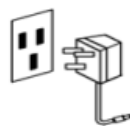
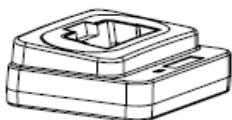
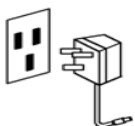

또는

- 1) AC 어댑터를 표준 전기 인출구에 꽂습니다.
- 2) 충전을 위하여 위키토키를 충전대에 꽂습니다.  
만충전에는 3 - 4 시간이 소요됩니다.









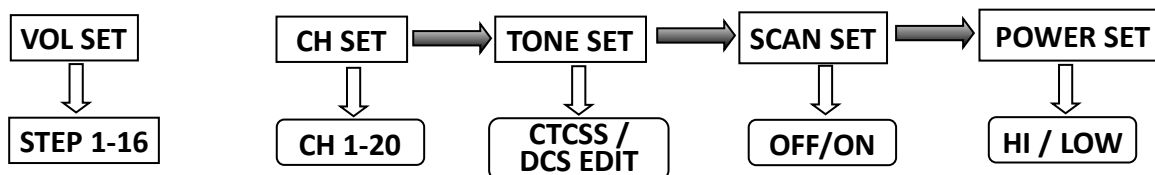











## 4. 메뉴 설정

### 4.1 【메뉴 설정】

때까지 [  ] 키와 [  ] Menu 모드로 들어가고, [  ] 키를 눌러 원하는 메뉴를 선택하고 [  ] 키를 눌러 기능을 선택한 다음 [  ] 키를 눌러 저장합니다. 아무런 조작이 없으면 10 초 후에 자동으로 메뉴 설정을 나갑니다.



## 5. 채널 설정 요약

- 장치 상단에 있는 [  ] 키를 누르고 있습니다.
- CH 문자가 점멸할 때까지 [  ] 키와 [  ] 키를 누르고 있고, [  ] 키를 눌러 채널 번호를 선택합니다.
- [  ] 키를 누르면 화면은 CTC off 를 표시하고, [  ] 키를 눌러 원하는 CTCSS/DCS ( CTCSS 1 – 53, DCS 1 – 104 )를 선택합니다.
- “SC\*\*\*” 가 점멸할때까지 (  ) 키를누르고 (  ) 러스캔 ON / OFF 를선택합니다 (  ) 키를눌러확인합니다.
- “Po\*\*\*” 가 점멸할때까지 [  ] 키를누르고 [  ] 키를눌러출력 Hi/Low 를선택하고 [  ] 키를눌러확인합니다.
- [  ] 키를 눌러 이 설정을 완료하거나 [  ] 키를 다시 눌러 다른 기능을 선택하고 [  ] 키를 눌러 기능의 Yes 또는 No 를 선택하고, 언제든지 [  ] 키를 눌러 이 설정을 완료할 수 있습니다.
- 측면의 [  ] 키를 누르고 동시에 [  ] 키를 눌러 장치를 잠금/해제하고 잠금 후에 장치는 볼륨을 조정하거나 송신 및 수신만 허용됩니다.

## 6. 주장

### 6.1 【전원 켜기 / 끄기】

무전기를 켜거나 끄려면, 전원 켜기 [○] 키를 누르고 있습니다.

### 6.2 【볼륨】

[▽|△] 키를 사용하여 볼륨 레벨을 조절합니다(16 단계, 기본 8)

### 6.3 【송신】

송신하려면 [☐] 키를 누른 채 마이크에서 약 5cm 에서 말합니다.

[☐] 키를 놓으면 대기 모드로 돌아갑니다.

### 6.4 【수신】

선택된 채널에서 활동을 청취합니다.

### 6.5 【키 잠금】

[☐] 키와 [△] 키를 동시에 눌러 키 잠금 ON / OFF 를 선택합니다.

### 6.6 【채널 선택】

“\*\* CH”가 점멸할 때까지 [☐] 키와 [▽] 키를 동시에 눌러 키를 누르고 [▽|△] 키를 눌러 채널 번호를 선택하고 [☐] 키를 눌러 확인합니다. 채널을 신속하게 선택하려면 [▽|△] 키를 누릅니다.

### 6.7 【CTCSS / DCS】

설정 중에 “CTCSS / DCS\*\*\*”가 점멸할 때까지 [☐] 키를 누르고 [▽|△] 키를 눌러 CTCSS / DCS 번호를 선택하고 [☐] 키를 눌러 확인합니다.

### 6.8 【스캔】

설정중에 “SC\*\*\*” 가점멸할때까지 (☐) 키를누르고 (▽|△) 러스캔 ON/OFF 를선택합니다 (☐) 키를눌러확인합니다.

### 6.9 【출력선택】

설정중에 “Po\*\*\*” 가점멸할때까지 [☐] 키를누르고 [▽|△] 키를눌러출력 Hi/Low 를선택하고 [☐] 키를눌러확인합니다.

### 6.10 【지능형 이어폰-마이크 조절】

이어폰 마이크를 꺾을 경우에 장치는 자동으로 볼륨을 편안한 레벨(본래 공장 또는 사용자가 설정한 것 중 낮은 레벨로 리셋합니다).

## TECHNICAL SPECIFICATIONS

<b>General</b>			
Battery type		Li-ion battery	
Battery capacity		1100mAh	
Temperature range		20°C-+55°C	
Frequency stability		±2.5ppm	
Size (HxWxD)		75x42x17mm	
Weight Incl. battery		75g	
Sub tones		CTCSS/DCS	
CP225A	Australia	Frequency range	476.425 –477.4125 MHz
		Channels	80 CHs
CP225B	British Malaysia Singapore	Frequency range	446.00625– 446.09375MHz
		Channels	8 CHs
CP225C	China	Frequency range	409.7500 – 409.9875MHz
		Channels	20 CHs
CP225E	E U	Frequency range	446.00625–446.09375MHz
		Channels	8 CHs
CP225H	Hong Kong, Macau	Frequency range	409.7500 – 409.9875MHz
		Channels	20 CHs
CP225J	Japan	Frequency range	422.05 – 422.30 MHz
		Channels	20 CHs
		Frequency range	Tx 440.025 – 440.3625 MHz Rx 421.575 – 421.9125 MHz
		Channels	27 CHs
CP225K	Korea	Frequency range	448.750 – 449.2625MHz
		Channels	25 CHs
CP225T	Taiwan	Frequency range	467.5125 – 467.6750MHz
		Channels	14 CHs
CP225R	Russia	Frequency range	433.07500–434.77500MHz
		Channels	69 CHs
		Frequency range	446.00625–446.09375MHz
		Channels	8 CHs
CP225U	USA	Frequency range	462.5500 – 467.7125MHz
		Channels	22 CHs



**CTCSS**

CH	Frequency	CH	Frequency	CH	Frequency	CH	Frequency
1	67.0	14	107.2	27	167.9	40	159.8
2	71.9	15	110.9	28	173.8	41	183.5
3	74.4	16	114.8	29	179.9	42	189.9
4	77.0	17	118.8	30	186.2	43	196.6
5	79.7	18	123.0	31	192.8	44	199.5
6	82.5	19	127.3	32	203.5	45	206.5
7	85.4	20	131.8	33	210.7	46	229.1
8	88.5	21	136.5	34	218.1	47	254.1
9	91.5	22	141.3	35	225.7	48	165.5
10	94.8	23	146.2	36	233.6	49	171.3
11	97.4	24	151.4	37	241.8	50	177.3
12	100.0	25	156.7	38	250.3	51	60.7
13	103.5	26	162.2	39	69.3	52	62.5
						53	64.7

**DCS**

CH	DCS Code	CH	DCS Code	CH	DCS Code	CH	DCS Code
1	023	28	172	55	431	82	743
2	025	29	174	56	432	83	754
3	026	30	205	57	445	84	036
4	031	31	223	58	464	85	053
5	032	32	226	59	465	86	122
6	043	33	243	60	466	87	145
7	047	34	244	61	503	88	212
8	051	35	245	62	506	89	225
9	054	36	251	63	516	90	246
10	065	37	261	64	532	91	252
11	071	38	263	65	546	92	255
12	072	39	265	66	565	93	266
13	073	40	271	67	606	94	274
14	074	41	306	68	612	95	325
15	114	42	311	69	624	96	332
16	115	43	315	70	627	97	356
17	116	44	331	71	631	98	446
18	125	45	343	72	632	99	452
19	131	46	346	73	654	100	454
20	132	47	351	74	662	101	455
21	134	48	364	75	664	102	462
22	143	49	365	76	703	103	523
23	152	50	371	77	712	104	526
24	155	51	411	78	723		
25	156	52	412	79	731		
26	162	53	413	80	732		
27	165	54	423	81	734		

## ■ WARRANTY

CPS Telecom will give 12 months warranty against failure made by the manufacturer from the date of purchase. The warranty will not cover damage made by the user, the user opening the equipment, moist, dirt, heat or cold. The warranty will not cover lightning/overvoltage.

Please contact your dealer if a problem with the equipment arises.

## ■ WASTE DISPOSAL

Electrical and electronic products can contain materials, parts and units that can be dangerous for the environment and human health. Products marked with the WEEE mark (shown below), shall not be disposed together with your normal household waste. Please inform yourself about the local rules and disposal collection system for electrical and electronic products. The correct disposal of your old product will help to prevent negative consequences for the environment and human health.



(WEEE = Waste of Electrical & Electronic Equipment).

## EU DECLARATION OF CONFORMITY

We, CPS Telecom Limited ( 15B/F., 55 King Yip Street, Kowloon, Hong Kong ) hereby declare that CP225 satisfies all the technical regulations applicable to the product within the scope of Council Directives 2014/53/EU :

Product Description : Walkie Talkie

Model Number : CP225

Brand : CPS

Hardware Version : CP225\_V2.0

Software Version : Vr80E

Power Adaptor : K05S050100G

Applicable Standards :

Safety : EN 60950-1:2006+A1:2009+A1:2010+A12:2011+A2:2013

EMC : ETSI EN 301 489 -1 V2.1.1: 2017-02

ETSI EN 301 489 -5 V2.1.1: 2016-11

Radio : ETSI EN 300 296 V2.1.1: 2016-03

**CPS Telecom Limited**

[www.cps-telecom.com](http://www.cps-telecom.com)

[cs@cps-telecom.com](mailto:cs@cps-telecom.com)





---

[http:// www.cps-telecom.com](http://www.cps-telecom.com)

**CPS** is the registered trademark of CPS Telecom Limited, Hong Kong  
© 2019 CPS Telecom Limited CPS20190418225V.1.2